

# PRODUCT COMPARISON:

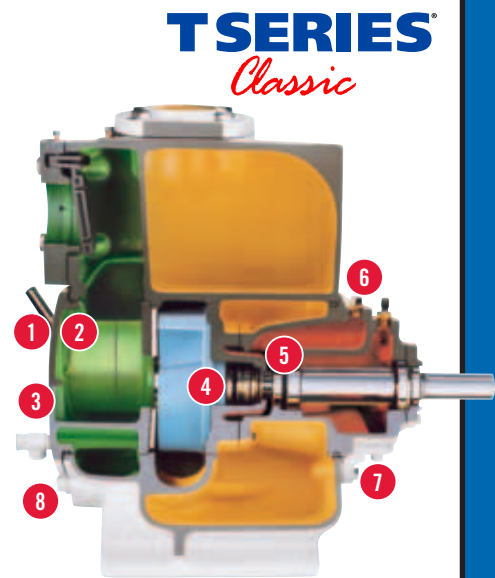

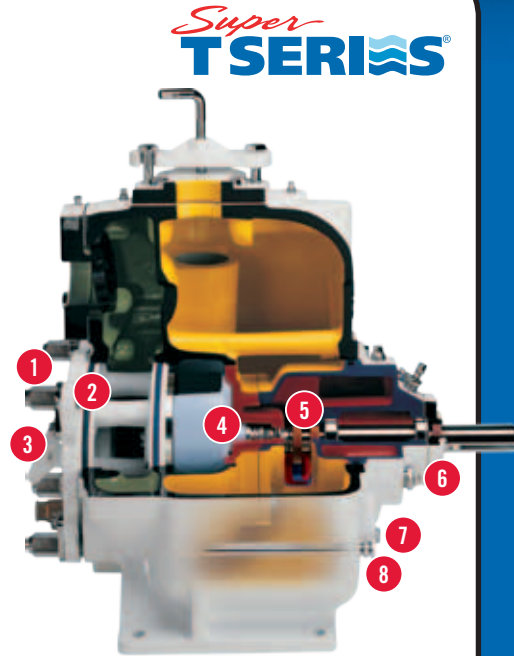

## Super T Series® vs. T Series® Classic

	Super T Series®	T Series® Classic
<b>1 Impeller to Wear Plate Clearance Adjustment</b>	External shimless and indexable adjustment via unique locking collar design	Adjustment via insertion of shims between rotating assembly and volute casing
<b>2 Coverplate</b>	Four point attachment with additional O-ring between vacuum and pressure chambers	Two point attachment with single O-ring at the outer bore
<b>3 Coverplate Removal</b>	Pusher bolt holes and easy grip handle provided	Cover can be pried from volute with pry bars
<b>4 Rotating Assembly</b>	Interchangeable with T Series® Classic Rotating Assembly	Interchangeable with Super T Series® Rotating Assembly
<b>5 Atmospheric Isolation</b>	Double lip seal with atmospheric barrier allows for external monitoring	Single lip seal with vented pipe plug
<b>6 Seal Oil Monitoring</b>	Via clear sight gauge	Via removal of seal chamber vent plug
<b>7 Rotating Assembly Removal</b>	Eased by pusher bolt capability	Can be aided with pry bars
<b>8 Volute Casing Heater</b>	Discreet heater port permits heater insertion into discharge side of volute	Heater probe can be inserted into optional service tee in pump drain port



# Parts Interchangeability

## Super T Series<sup>®</sup> vs. T Series<sup>®</sup> Classic

	Size	Common Parts	Interchangeable	Not Interchangeable
	3"	Impeller, Seal Assembly, Outboard & Inboard Bearings, Seal Plate, Wear Plate Assembly	Rotating Assembly, and Pump footprints are identical	Volute Casing, Back Coverplate Assembly, Impeller Shaft
	4"	Impeller, Seal Assembly, Seal Plate, Wear Plate Assembly	Rotating Assembly, and pump footprints are identical	Volute Casing, Back Coverplate Assembly, Bearings, Impeller Shaft
	6"	Wear Plate Assembly	Rotating Assembly, and pump footprints are identical	Volute Casing, Back Coverplate Assembly, Impeller, Seal Plate, Bearings, Impeller Shaft
	8"	Impeller, Seal Assembly, Outboard & Inboard Bearings, Seal Plate, Wear Plate	Rotating Assembly, and pump footprints are identical	Volute Casing, Back Coverplate Assembly, Impeller Shaft
	10"	Impeller, Outboard & Inboard Bearings	Rotating Assembly, and pump footprints are identical	Volute Casing, Seal Plate, Impeller Shaft