

Ampco Pumps Company

Marine and Industrial CENTRIFUGAL PUMPS

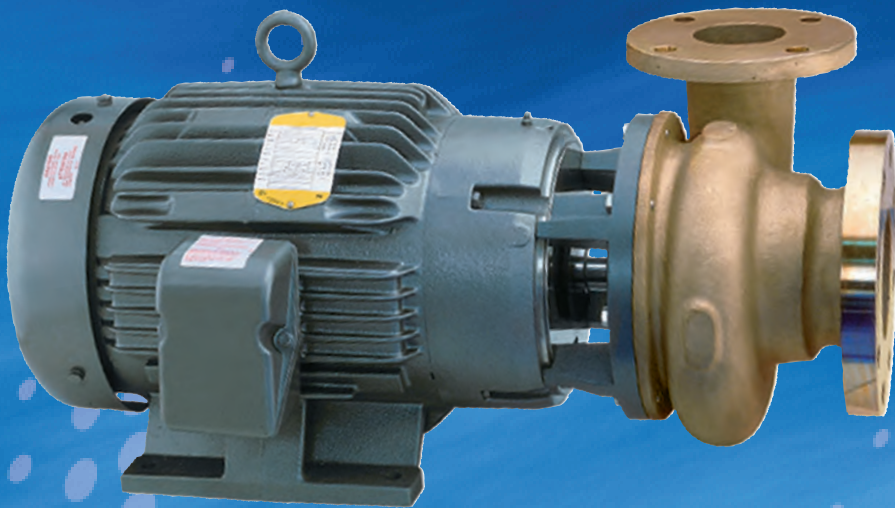

K SERIES
NICKEL ALUMINUM BRONZE
316 STAINLESS STEEL
DUPLEX 2205



Z SERIES
NICKEL ALUMINUM BRONZE
316 STAINLESS STEEL
DUPLEX 2205



R SERIES
NICKEL ALUMINUM BRONZE
316 STAINLESS STEEL

Marine and Industrial Centrifugal Pumps

All K, Z, R Series pumps feature:

- Heavy-wall construction with tight manufacturing tolerances
- High-efficiency design with fully-shrouded, dynamically-balanced impellers
- Close-coupled on JM, 56J, IEC frame motors
- The standard seal is a T21 single mechanical with ceramic seat, carbon rotating element, Buna elastomers and 304SS metalics. Various other seal options are available.
- ABS (American Bureau of Shipping) type approval available
- Capacities from 5-3000 GPM, 1-680 m³/h
- Bearing frame mounting available

K Series

- Pressure up to 150 psi, 10 bar
- Temperatures up to 225°F, 105°C
- Multiple seal options
- Enclosed impellers
- Close-coupled to NEMA motor

R Series

- Self-priming up to 25 ft., 7.6m
- Pressure up to 175 psi, 12 bar
- Temperatures up to 225°F, 105°C
- Multiple seal options
- Enclosed impellers
- Close-coupled to NEMA or IEC motor

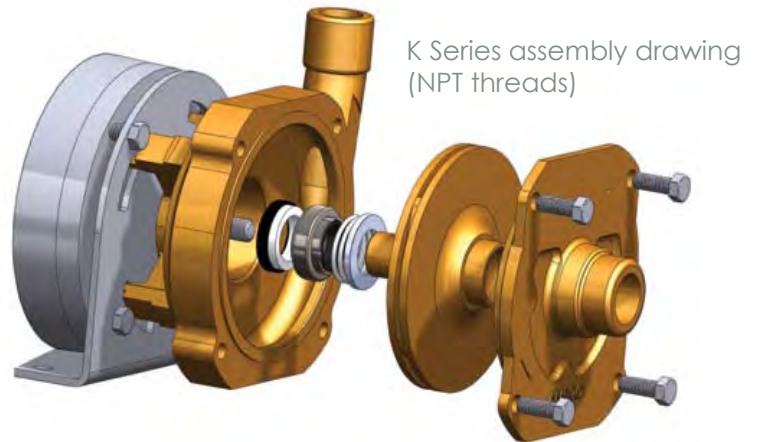

Z Series

- Pressure up to 175 psi, 12 bar
- Temperatures up to 250°F, 120°C
- Multiple seal options
- Internal Seal flush
- Replaceable wear rings
- Close-coupled to NEMA or IEC motor

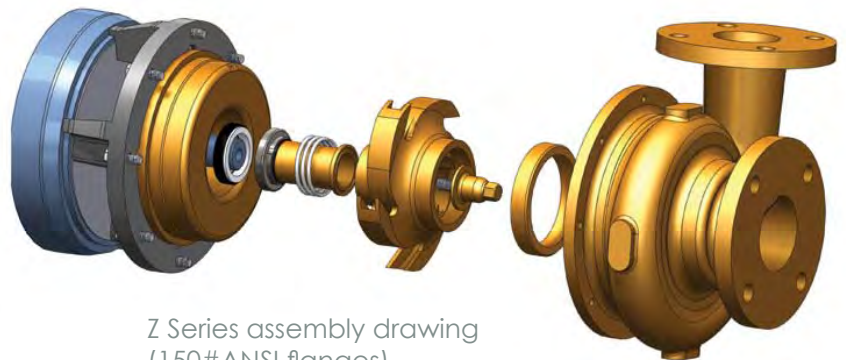

Applications

- Commercial saltwater applications
- Reverse osmosis
- On-board vessels
- Engine cooling, condenser cooling, refrigeration and fire pumps
- Effluent waste water, brackish water

Available Alloys

Ampco offers pumps in nickel aluminum bronze, 316 stainless steel and Duplex 2205 stainless steel construction. All three alloys are in stock and available for delivery in one week. Ampco application engineers will help select the right alloy for the application.

Nickel aluminum bronze - Z, K, R

- Corrosion/erosion resistance to saltwater is far superior to stainless steel or standard bronzes
- Cost effective material for saltwater, brackish water and waste water
- The U.S. Navy has been using CDA958 in saltwater applications for over 40 years
- Ampco's K, Z and R series pumps have been used on most of the U.S. Army's reverse osmosis systems since the 1980's

316 stainless steel - Z, K, R

- High resistance to corrosion from many chemical solutions
- The material of choice in food and beverage processing applications

Duplex 2205 - Z, K

- Recommended for saltwater applications with higher salinity (over 35,000 ppm), higher temperatures, and high concentration of hydrogen sulfides (such as pumping from a deep seawater well)
- Superior resistance to effects of cavitation
- Strong resistance to wear from abrasive media such as diatomaceous earth or ethanol

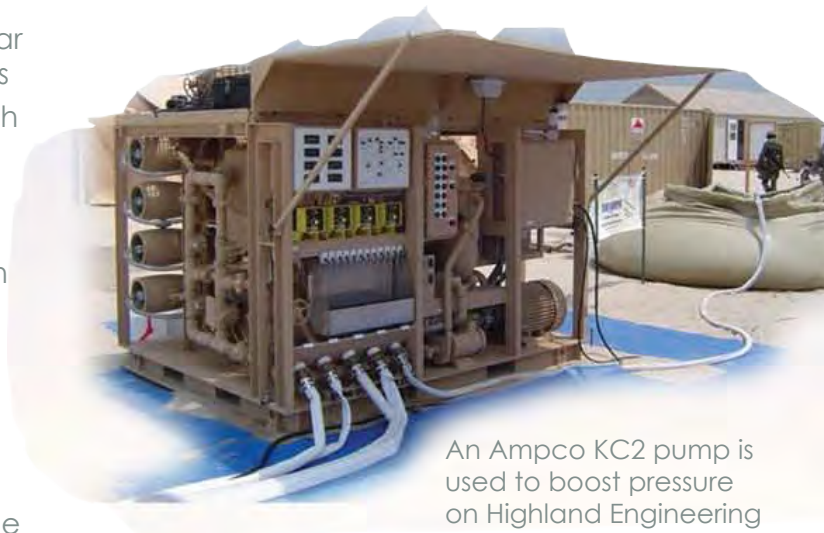

An Ampco KC2 pump is used to boost pressure on Highland Engineering Inc.'s 1500 ROWPU system

K, Z and R Series pumps are also available in specialty alloys such as Hastalloy C, Alloy 20, and 316L stainless steel.

A complete alloy compatibility chart is available at www.ampcopumps.com

Reverse Osmosis and Desalination

Ampco pumps are commonly used in difficult applications in wastewater and desalination industries.



K Series

AMPCO PUMPS COMPANY, INC.
K-SERIES COMPOSITE

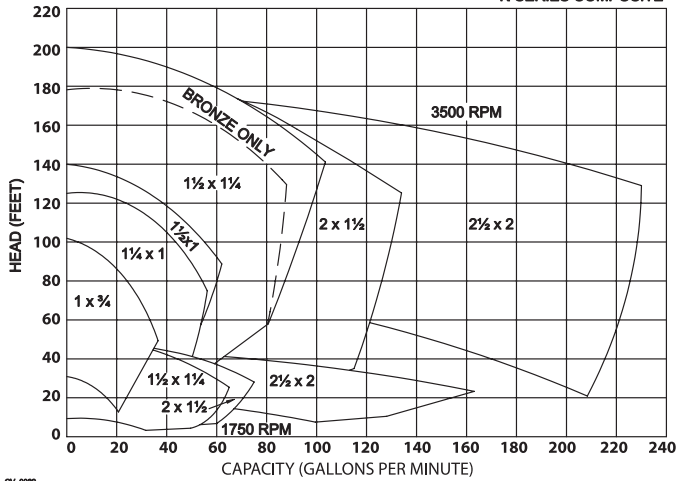

01_009

R Series

AMPCO PUMPS COMPANY, INC.
R-SERIES COMPOSITE

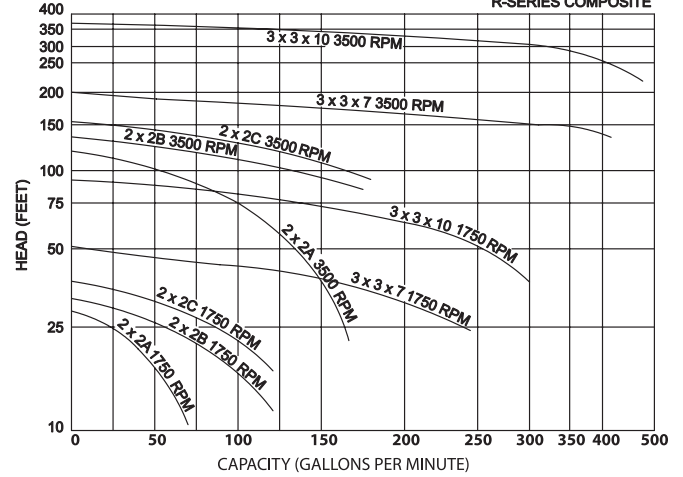

Z Series

AMPCO PUMPS COMPANY, INC.
Z-SERIES COMPOSITE

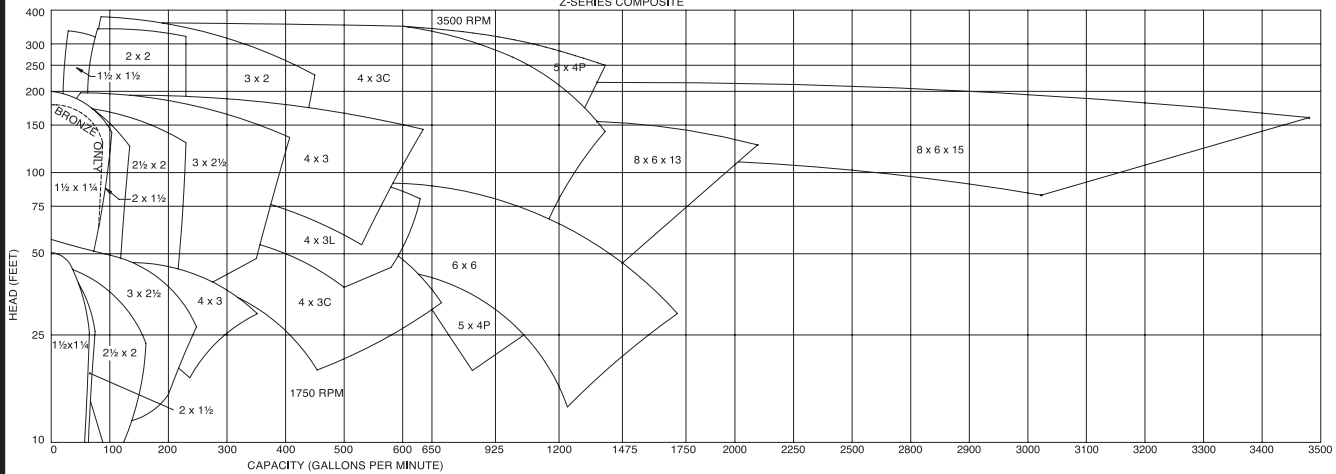

01_011

All assembled Ampco pumps are tested to verify hydraulic, mechanical and electrical performance prior to shipment.

Ampco pumps are manufactured, assembled and tested in Glendale, Wisconsin USA.

Ampco Pumps Company

Ampco Pumps Company
2045 W. Mill Road
Glendale, WI 53209
Phone: 800.737.8671
Fax: 414.643.4452
sales@ampcopumps.com

www.ampcopumps.com

Ampco Pumps GmbH
Am Gäxwald 6
76863 Herxheim Germany
Phone: +49 7276 5058515
Fax: +49 7276 5058517
info@ampcopumps.de