



Goulds HSU, HSUL & JCU

Submersible Pumps



ITT

ENGINEERED FOR LIFE

Goulds HSU, HSUL, JCU

Model HSU

Hydro-solids pumps. Recessed impeller easily accommodates large, stringy and fibrous solids without clogging. Because it is completely submersible, the HSU can be used in virtually any sump application.

- Capacities to 1,300 GPM (295 m³/h)
- Heads to 90 feet (27 m)
- Temperatures to 194°F (90°C)
- Pressures to 100 PSIG (690 kPa)
- Solids to 6 inches (152 mm)

Solids Type

Will handle large, stringy, fibrous and abrasive solids.

Materials

Cast Iron
28% Chrome Iron (HC600)
CD4MCu
316 Stainless Steel

Features

- Recessed Impeller
- Concentric Casing
- Integral Support
- Heavy Duty Adapter
- Integral Discharge Elbow



Model HSUL

Submersible recessed impeller pumps easily handle any solid up to its suction/discharge size. Versatile mounting allows pump to stand or to be mounted on an optional slide rail arrangement.

- Capacities to 2,800 GPM (636 m³/h)
- Heads to 140 feet (43 m)
- Temperatures to 194°F (90°C)
- Pressures to 100 PSIG (690 kPa)
- Solids to 6 inches (152 mm)

Solids Type

Will handle large, stringy, fibrous, and abrasive solids.

Materials

Cast Iron
28% Chrome Iron (HC600)
CD4MCu
316 Stainless Steel

Features

- Recessed Impeller
- Concentric Casing
- Flanged Suction and Discharge
- Interchangeability with Horizontal and Vertical Models
- Mounting Flexibility



Model JCU

Submersible pumps for handling tough abrasive slurries. Impeller design offers optimum combination of solids handling ability, wear resistance, and efficiency. Optional slide rail assembly available for ease of maintenance.

- Capacities to 4,000 GPM (910 m³/h)
- Heads to 220 feet (67 m)
- Temperatures to 194°F (90°C)
- Pressures to 200 PSIG (1,380 kPa)
- Solids to 2 inches (152 mm)

Solids Type

Will handle all types of abrasive solids

Materials

Cast Iron
28% Chrome Iron (HC600)
CD4MCu
316 Stainless Steel

Features

- Heavy Duty Slurry Design
- Replaceable Suction Liner
- Integral Strainer
- Mounting Flexibility
- Interchangeability with Horizontal and Vertical Models



Model HSU

Submersible Hydro-Solids Pumps

Designed to Handle Large, Stringy, Fibrous and Abrasive Solids

Services

- Waste Treatment Plants
- General Service Sumps
- Sewage Wet Wells
- Reclaim Sumps
- Power Plants
- Industrial Waste Sumps
- Sludge Pits
- Drainage Sumps
- Collection Basins
- Wood Yard Sumps



What Goes In – Goes Out!

Unlike self-priming trash pumps or some other submersibles or vertical pumps, the HSU will pump any solid that enters its suction without clogging. This includes such hard to pump items as rags and string. Avoid costly downtime unplugging your pump with Goulds HSU.

Hydraulic Coverage 50 / 60 Hz

Design Features

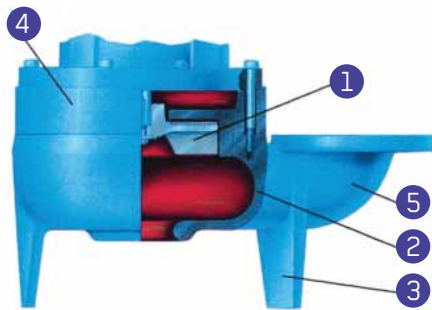

- 1 Fully Recessed Impeller** Allows large stringy or fibrous material to pass through the pumps without binding or clogging.
- 2 Concentric Casing** Concentric design facilitates flow of pumpage and solids through the pump while minimizing loads.
- 3 Integral Support** Three cast-in legs provide simple, stable support without additional parts.
- 4 Heavy-Duty Motor Adaptor** Extra thick in critical areas. Extended shroud encircles impeller and protects casing from wear.
- 5 Integral Discharge Elbow** Cast-in elbow reduces parts and allows easy installation.

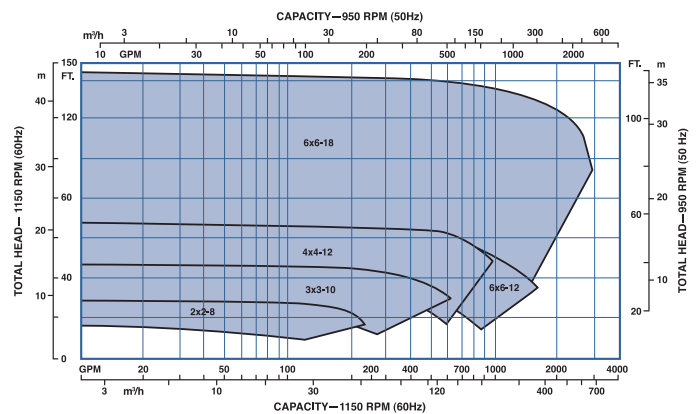
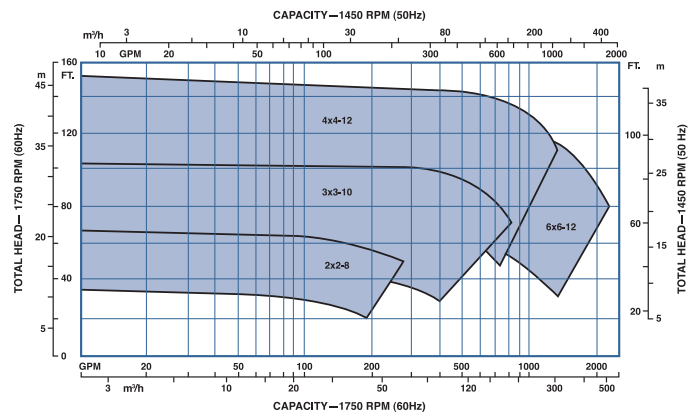

Model HSUL

Submersible Hydro-Solids Pumps

Designed to Handle Large/Stringy and Abrasive Solids

Services

- Waste Treatment Plants
- General Service Sumps
- Sewage Wet Wells
- Reclaim Sumps
- Power Plants
- Industrial Waste Sumps
- Sludge Pits
- Drainage Sumps
- Collection Basins
- Wood Yard Sumps



Design Features

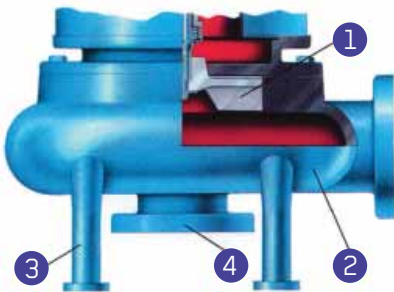

- 1 Fully Recessed Impeller** Allows large stringy or fibrous material to pass through the pump without binding or clogging.
- 2 Concentric Casing** Concentric design facilitates flow of pumpage and solids through the pump while minimizing loads.
- 3 Legs** Bolt-on legs provide stability on sump floor.
- 4 Mounting Flexibility** Flanged suction and horizontal discharge allow pump to stand or be mounted on optional slide rail.
- 5 Integral Discharge Elbow** Cast-in elbow reduces parts and allows easy installation.

Hydraulic Coverage 50 / 60 Hz

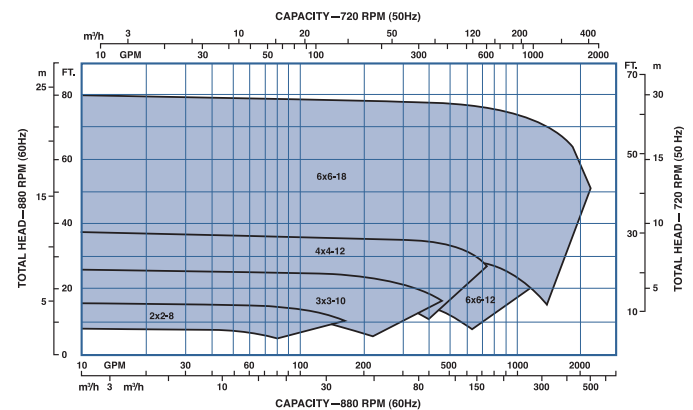
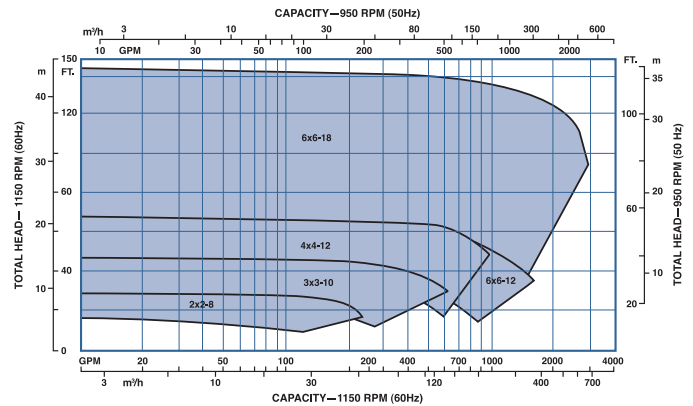
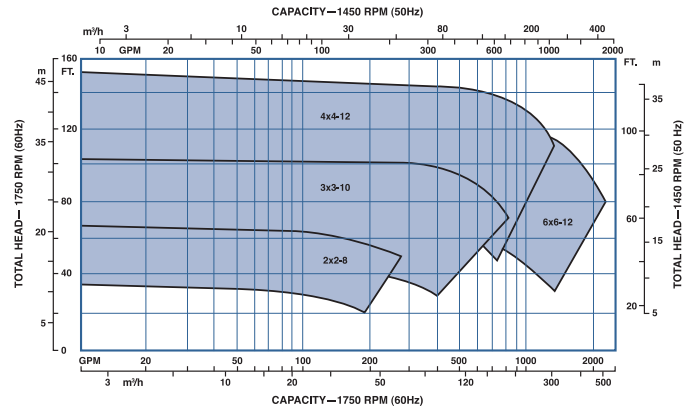

Model JCU

Heavy Duty Submersible Slurry Pumps Designed For Abrasive Sump Applications

Services

- Fly Ash
- Sand and Gravel
- Chemical Waste Sumps
- Dirty Water Sumps
- Foundry Sand
- Bauxite
- Lime Sumps
- Kaolin Clay
- Mill Scale
- Sludge Pits



Design Features

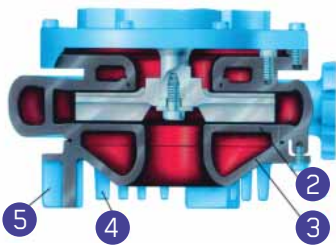

- 1 Heavy Duty Design** Extra thick wall sections in high wear areas.
- 2 Replaceable Suction Liner** Easy to replace – protects casing from wear.
- 3 Suction Cover** Bell shaped intake reduces entrance losses and improves suction characteristics.
- 4 Integral Strainer** Suction cover has cast-on vertical tines to prohibit oversized solids from clogging pump.
- 5 Pump Mounting** Three cast-on legs give excellent support and stability. Optional slide rail also available to permit easy removal from sump.
- 6 Maximum Interchangeability** Suction Cover Liner and Casing are interchangeable with Goulds Models JC (horizontal) and VJC (vertical cantilever) pumps.

Hydraulic Coverage 50 / 60 Hz

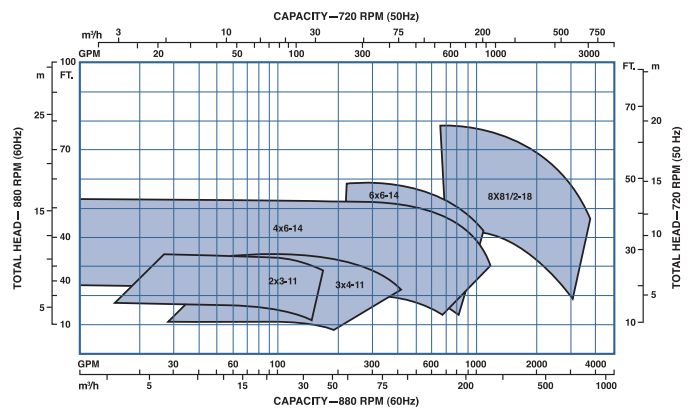
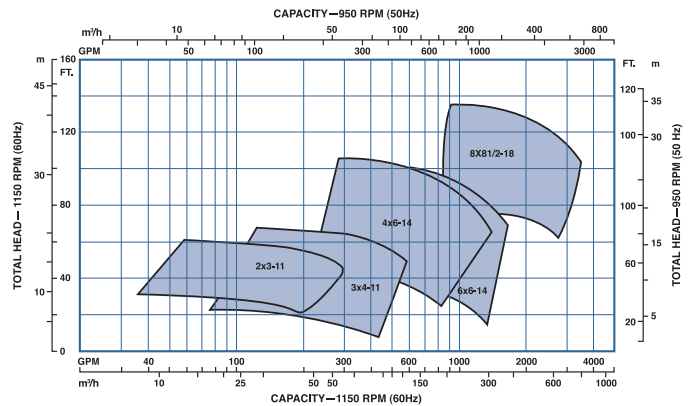
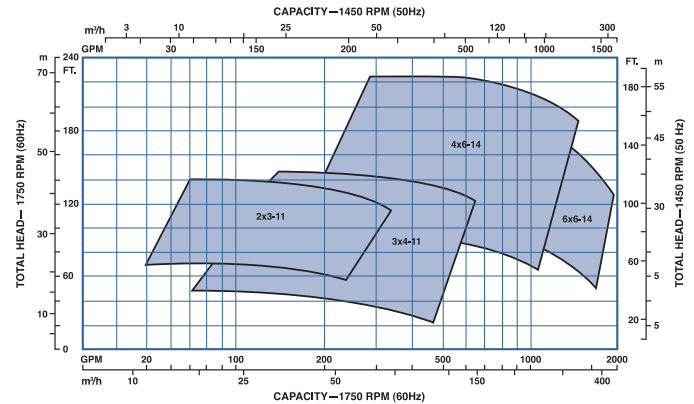

Options

For Application Flexibility

Slide Rail System

Available on Models HSUL and JCU, Goulds slide rail system provides easy removal of pump unit without disturbing discharge piping. Unique slurry design utilizes a locking cam action with locator lugs and a large O-ring for positive sealing (no leakage) while allowing a tangential discharge for high efficiency. This is an important feature when pumping slurries; if a tight seal is not achieved, leakage can cause rapid and excessive wear of the mating flanges resulting in reduction of performance as well as increased maintenance costs. Goulds slide rail system meets all requirements for toughest slurry devices.

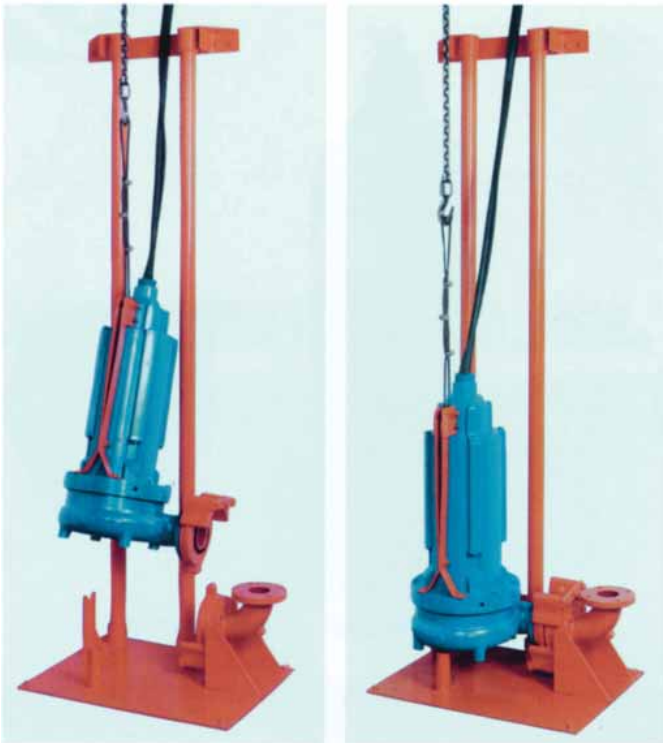

Moisture Detector

Required on all submersibles for warranty validation. Provides one normally open and two normally closed connection for activating a warning and/or de-energizing the motor.



Submersible Motors

Goulds submersible series motors are designed and built specifically for tough slurry pumping. Heavy-duty design features for reliability include:

- UL and CSA Approved Explosion Proof
- Epoxy encapsulated and butt-spliced cable entry system prevents liquid from entering top of motor and provides non-wicking design.
- Permanently lubricated and sealed ball bearings.
- F Class insulation and 1.15 service factor standard.
- Tandem mechanical seals provide complete protection for motor internals.
- Thermal protection standard.
- Dual moisture probes provide early warning of seal failure.
- Conforms to NEMA, IEEE, ANSI and NEC standards.
- High temperature option allows operation to 194° F (90° C).
- **5-year Pro-Rated Warranty**



Dimensions

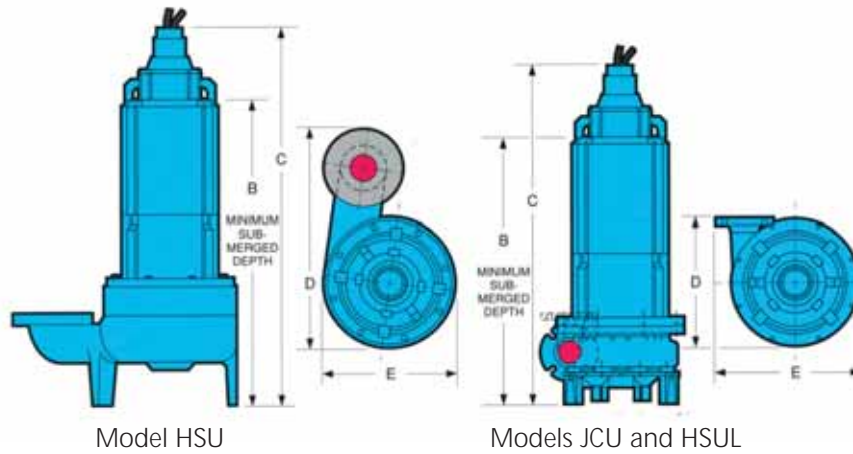

Model HSU

Models JCU and HSUL

Model	Pump Size	B*	C*	D	E	Weight Lbs. (kg)
HSU	3×3-8	32.3 (821)	39.8 (1010)	22.6 (575)	15.4(391)	470 (213)
	4×4-10	38.3 (972)	48.6 (1235)	28.6 (727)	18.3 (464)	1060 (481)
	6×6-11	45.6 (1159)	53.0 (1346)	32.0 (813)	20.3 (514)	1170 (531)
HSUL	2×2-8	32.0 (813)	40.0 (1016)	14.0 (356)	14.0 (356)	500 (227)
	3×3-10	42.0 (1067)	54.0 (1372)	19.0 (483)	19.0 (483)	1450 (658)
	4×4-12	44.0 (1118)	57.0 (1448)	21.0 (533)	21.0 (533)	1410 (640)
	6×6-12	57.0 (1448)	68.0 (1727)	24.0 (610)	23.0 (584)	1950 (885)
	6×6-18	57.0 (1448)	68.0 (1727)	30.0 (762)	29.0 (737)	2025 (918)
JCU	1×1.5-11	31.1 (790)	39.4 (1000)	19.5 (495)	15.4 (391)	500 (227)
	2×3-11	31.1 (790)	39.4 (1000)	23.1 (587)	17.2 (437)	500 (227)
	2×3-14	36.0 (914)	46.4 (1178)	25.8 (655)	20.3 (514)	900 (408)
	3×4-11	36.0 (914)	46.4 (1178)	26.5 (673)	19.3 (490)	990 (449)
	4×6-14	47.1 (1197)	58.0 (1473)	32.9 (836)	24.2 (614)	1880 (853)
	6×6-14	47.3 (1202)	58.2 (1478)	39.3 (998)	27.3 (692)	2030 (921)
	8×10-18	51.3 (1301)	62.9 (1597)	50.1 (1273)	34.8 (885)	2460 (1116)
	10×12-22	53.6 (1362)	64.5 (1638)	59.0 (1499)	43.1 (1095)	3280 (1488)

*Dimensions based on largest motor available for the given pump size.
All dimensions in inches and (mm). Not to be used for construction.

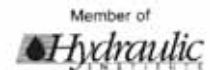

ENGINEERED FOR LIFE